



Development of a low carbon coupling device for solar cooling (photovoltaic + heat pump)

Task 53 

Philippe ESPARCIEUX , Olivier BAUP
ATISYS Concept

Daniel MUGNIER
TECSOL

Christophe WEBER, Christophe MARVILLET
NEOTHERM Consulting

Abu Dhabi, October 29th – November 2nd 2017

Goal of the project

2

- Produce cooling effect using low GWP* thermodynamic system **coupled to PhotoVoltaic (PV) plant** for driving, monitoring and supervision;
- Expect 80 % solar self sufficient;
- Monitor performances *«proof of the pudding is in the eating».*

*GWP: Global Warming Potential (PROPANE \cong 10)

Journée du 13 Avril 2016 (TOULON)

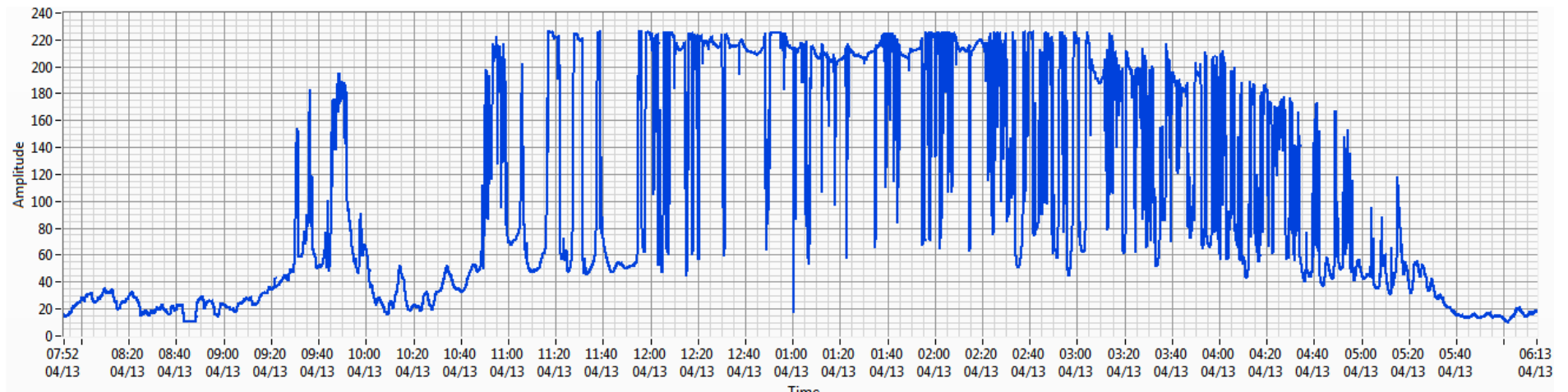

Electric problem

4

Compressor power supply needs being secured by external reliable complement (PDN, battery storage, ...)

- Possible **power complement** provided by external supply (PDN, generator, battery ...)
- PV **power excedent** is used for **thermal energy storage** or local inner use
- **power excedent** not injected to PDN because perturbations

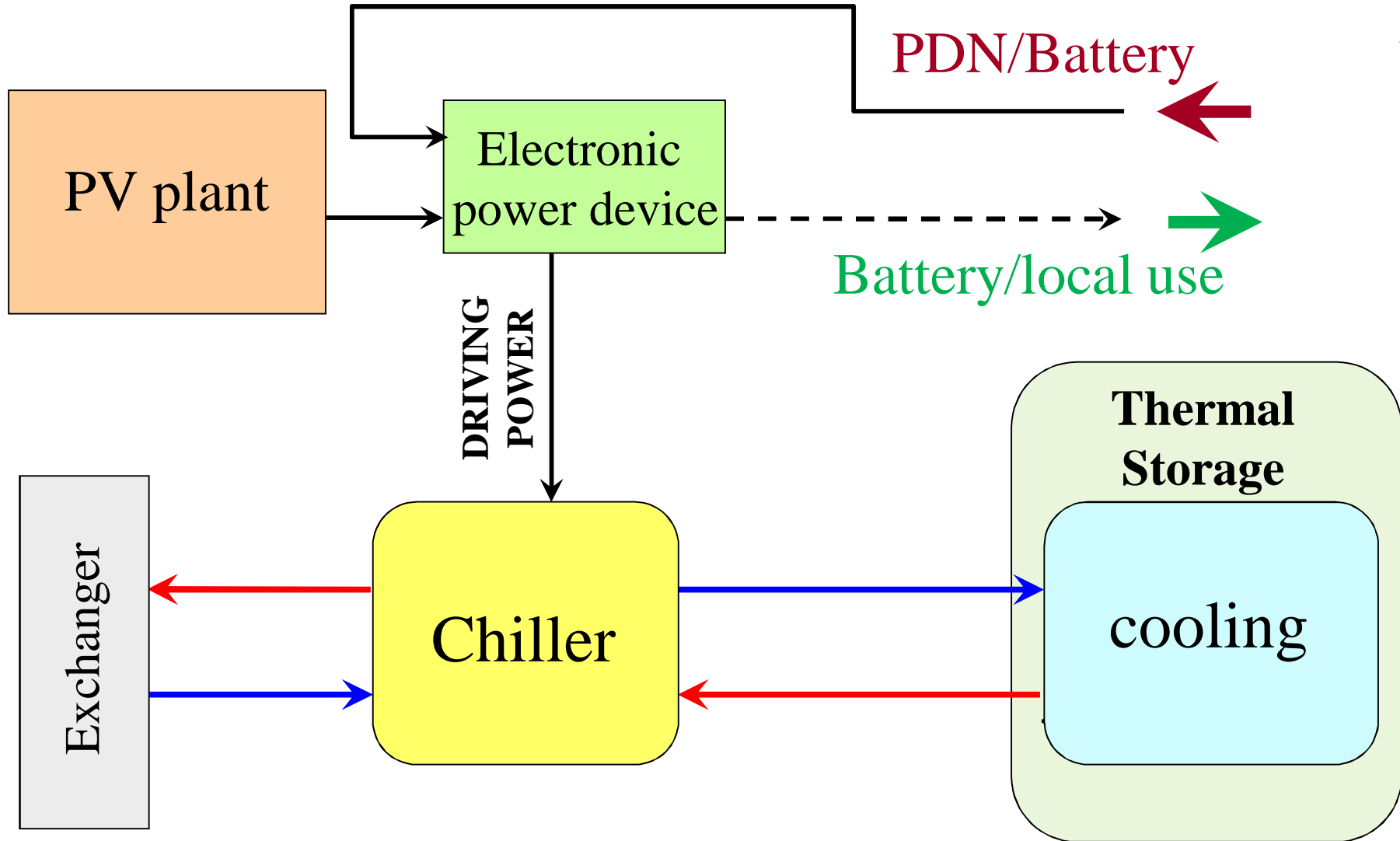

The thermal problem

6

- Define acceptable COP **chiller compressor working domain** (adjustable power)
- Analysis of **heat transfer fluid** regime for optimizing performances
- Storage and distribution **management**
- **Dimensioning** whole system

PV-COOLING power driving principle

7

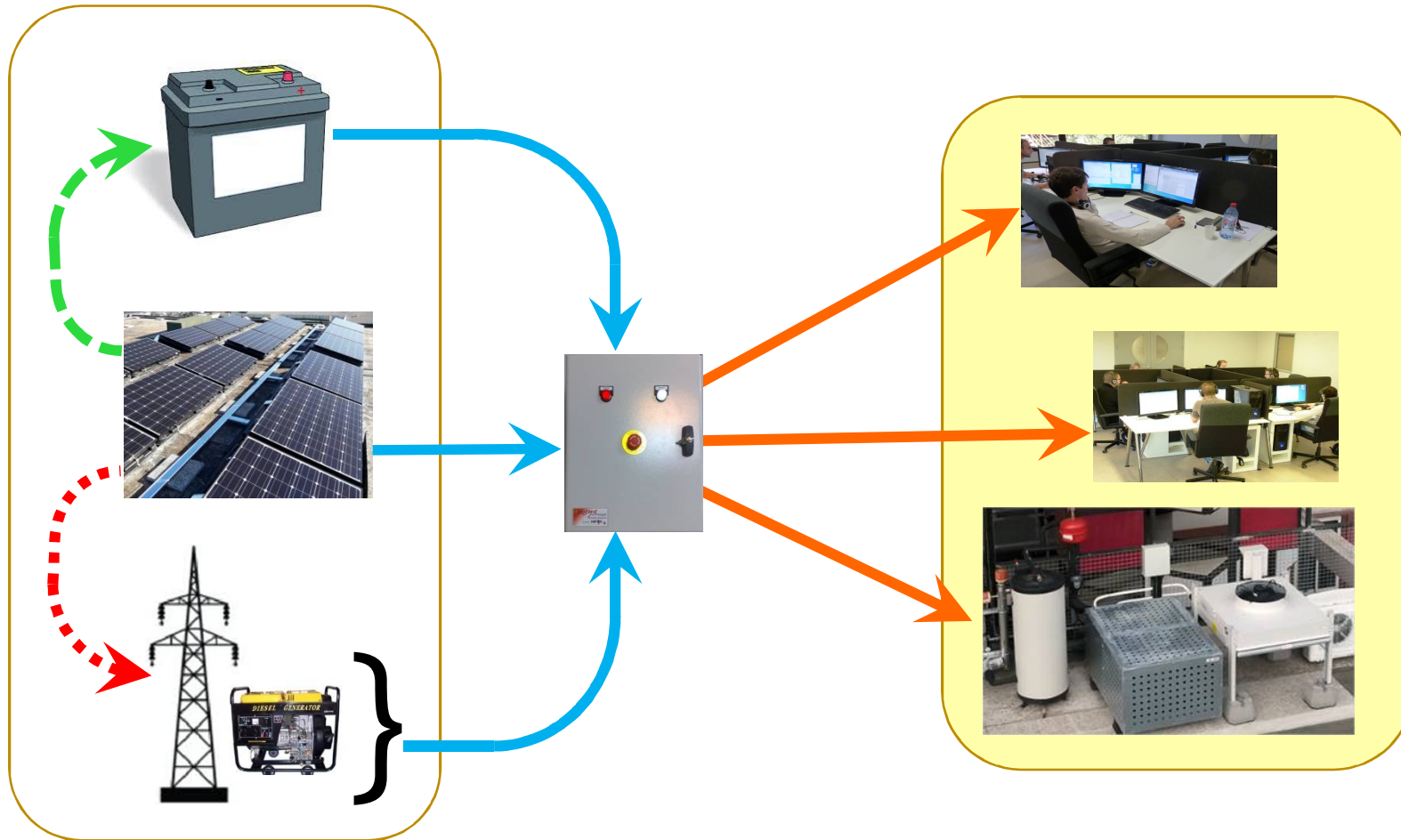

PV-COOLING basic architecture

8

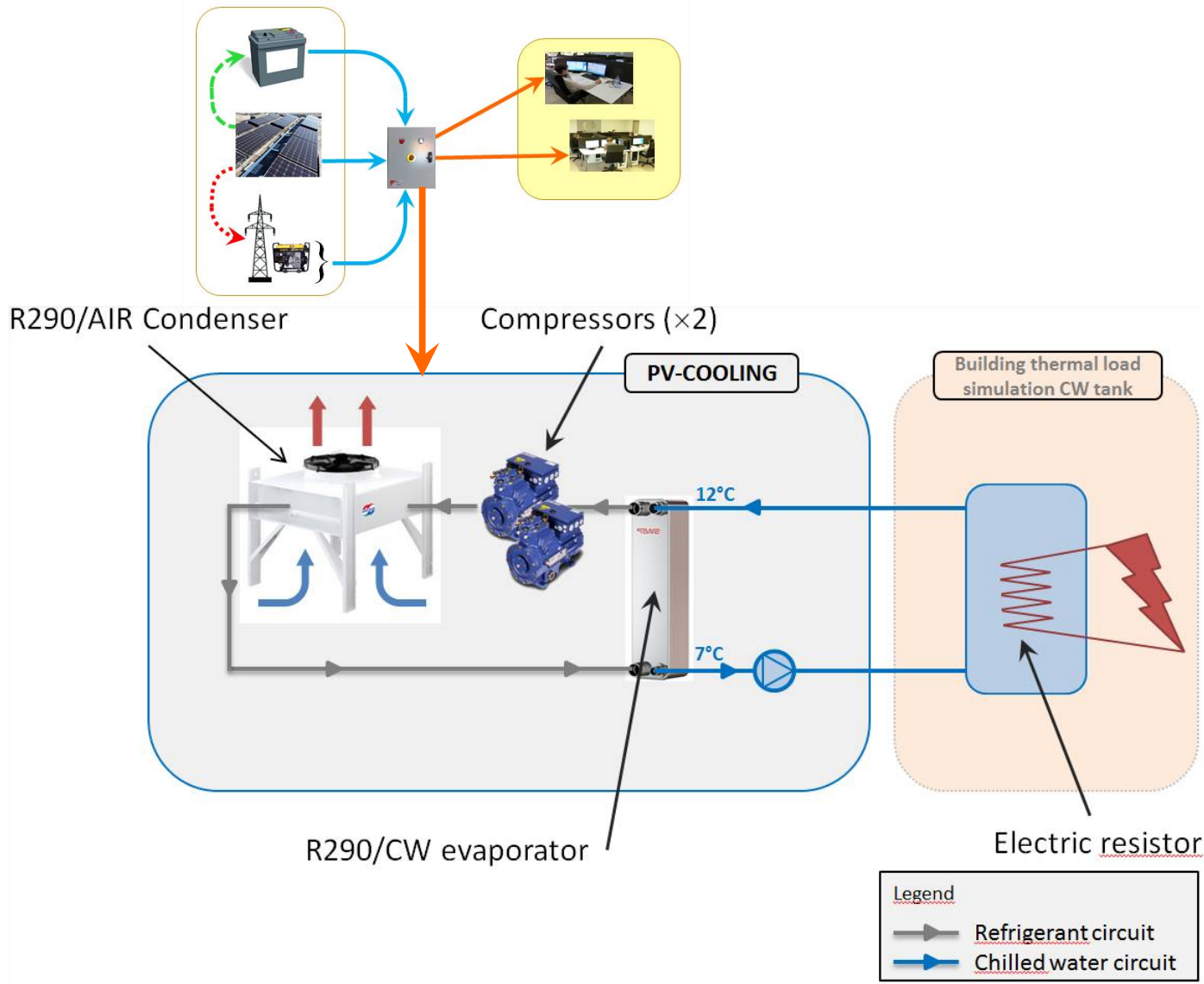

BUILDING THERMAL LOSS ESTIMATION (1)

9

$$P_{BuildLoad}(t) = G \times V \times [T_{ext}(t) - T_{set}(t)] + K \times S_{Build} P_{Sol.Ir}(t) * \delta(t - \tau)$$

- T_{ext} : outdoor temperature
- T_{set} : indoor setpoint temperature
- G : volume heat loss coefficient [$W/m^3 \cdot ^\circ C$] ($G=2.5$ - poorly insulated building)
- V : the cooled volume. $V=325 \text{ m}^3$
- $P_{Sol.Ir}$: Power of solar irradiation [W/m^2]
- S_{build} : time average wall surface of building exposed to solar irradiation (40 m^2)
- K : solar power absorption sensitivity of building walls [$0 \leq K \leq 1$](0.20)
- $\delta(t-\tau)$: delay function - thermal inertia of building to solar irradiation ($\tau = 1 \text{ hour}$)

PV-COOLING main components

10



Armoire réchauffeur



Coffret électrique, Onduleur, Variateurs, parc batterie

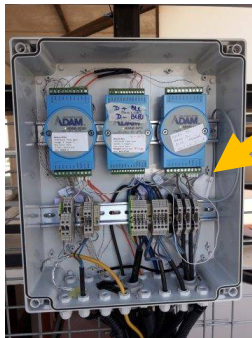

Coffret instrumentation



Champ PV

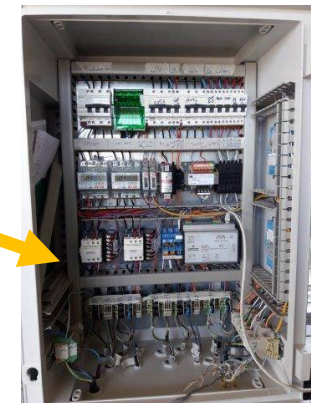

Armoire commande PV-COOLING

PV-COOLING real-time remote monitoring

11

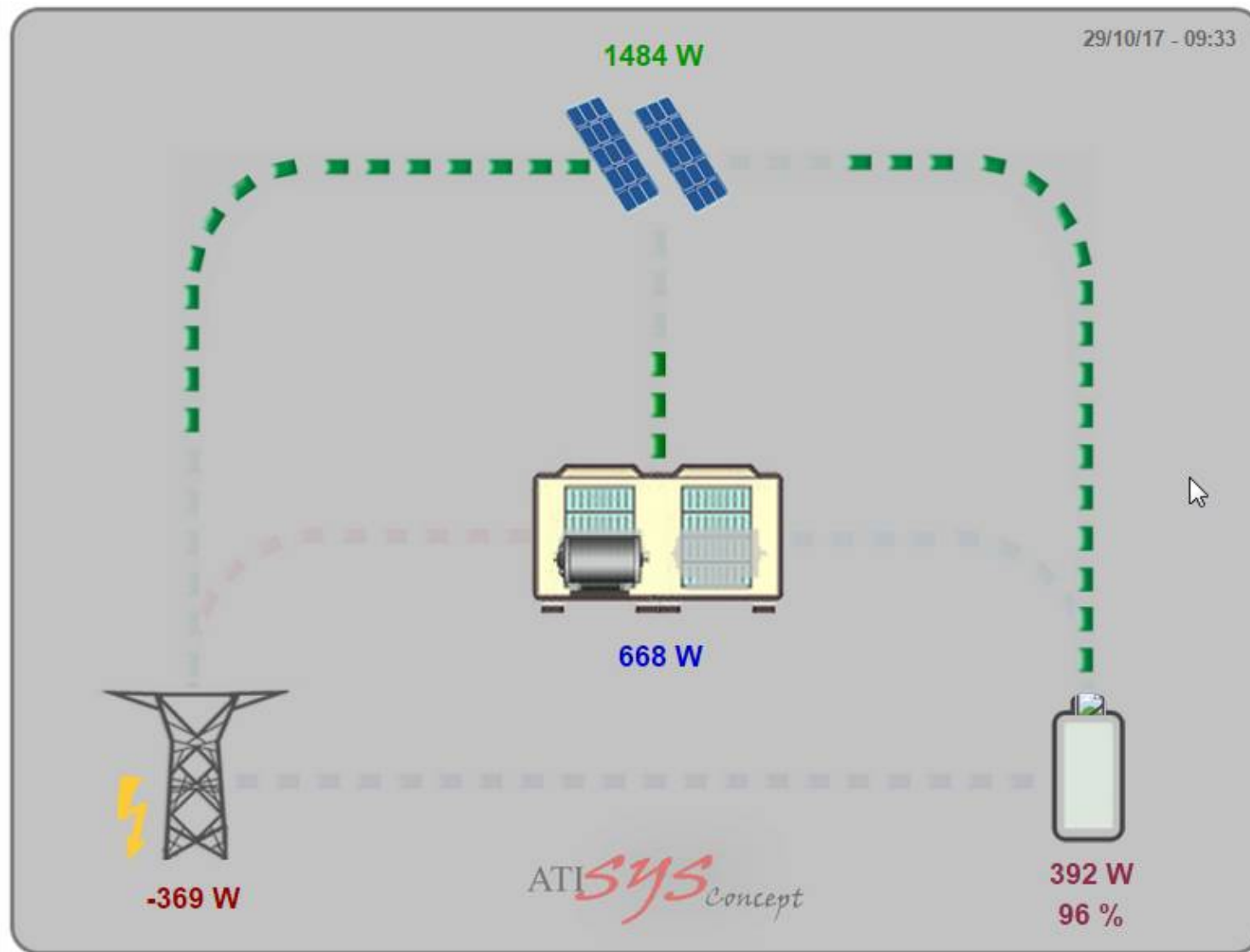

Sunny day – “eco” mode

12

PV power System consumption Battery power Grid power

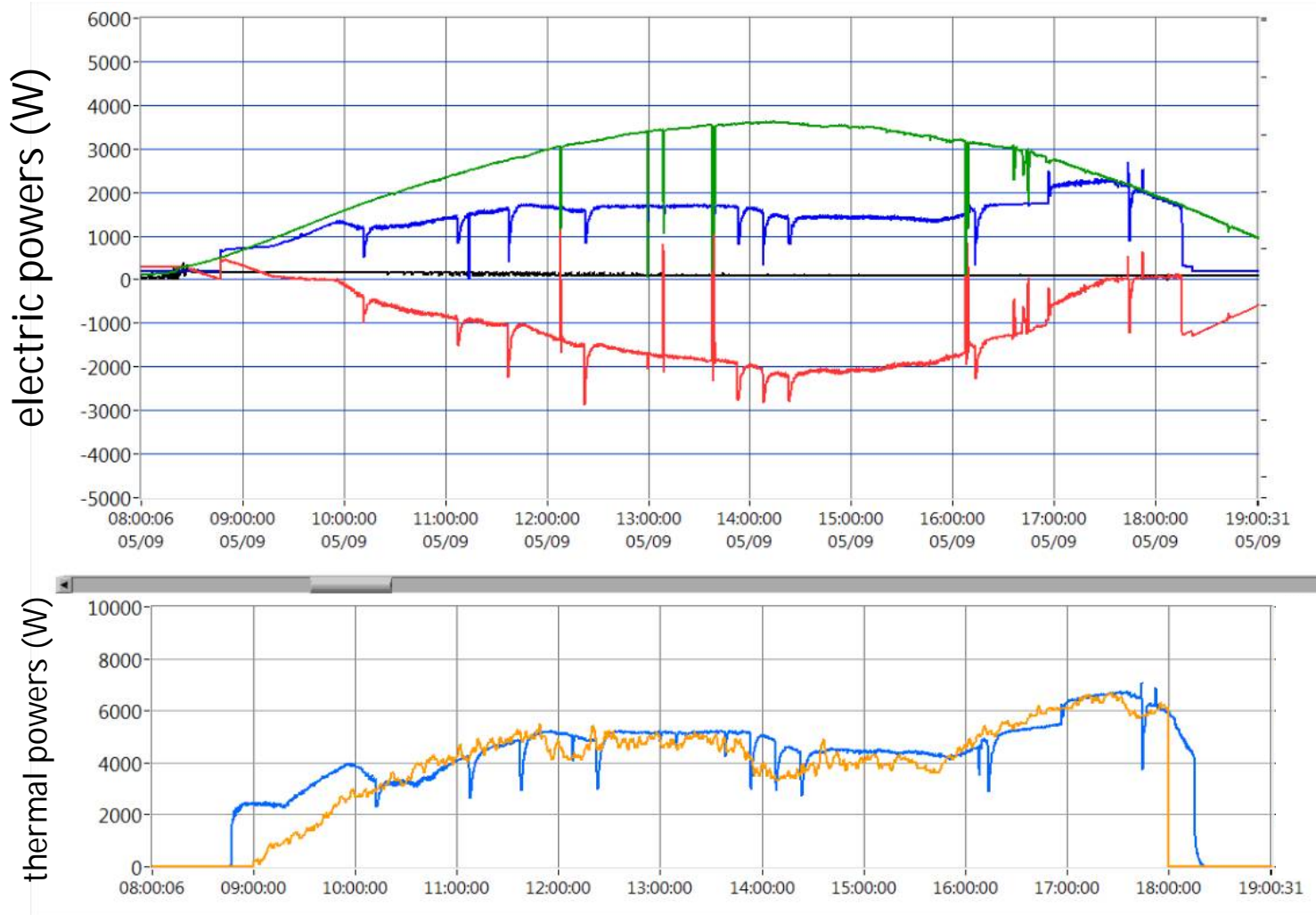

Building thermal load

Cooling power

Disrupted sunny/cloudy day – “eco”

PV power System consumption Battery power Grid power

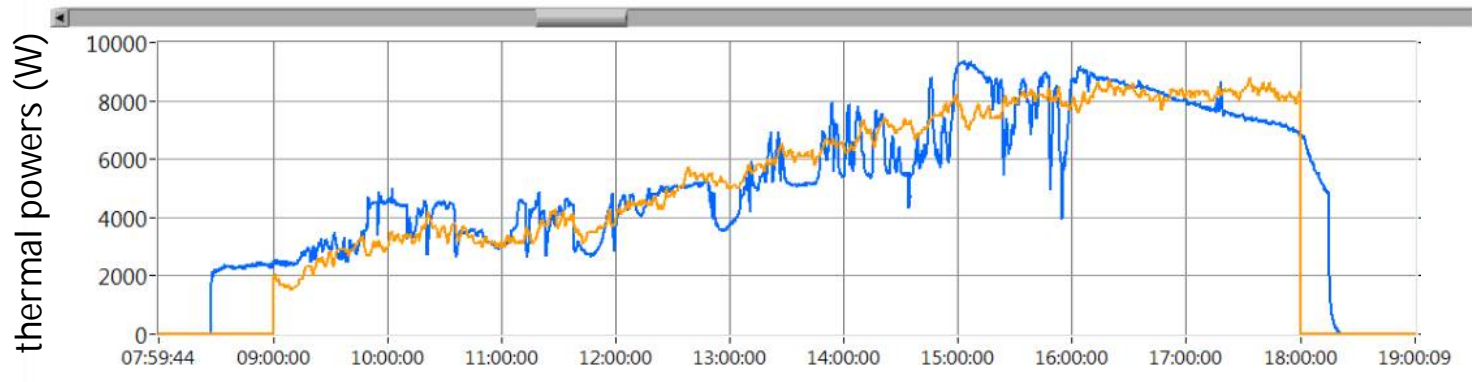
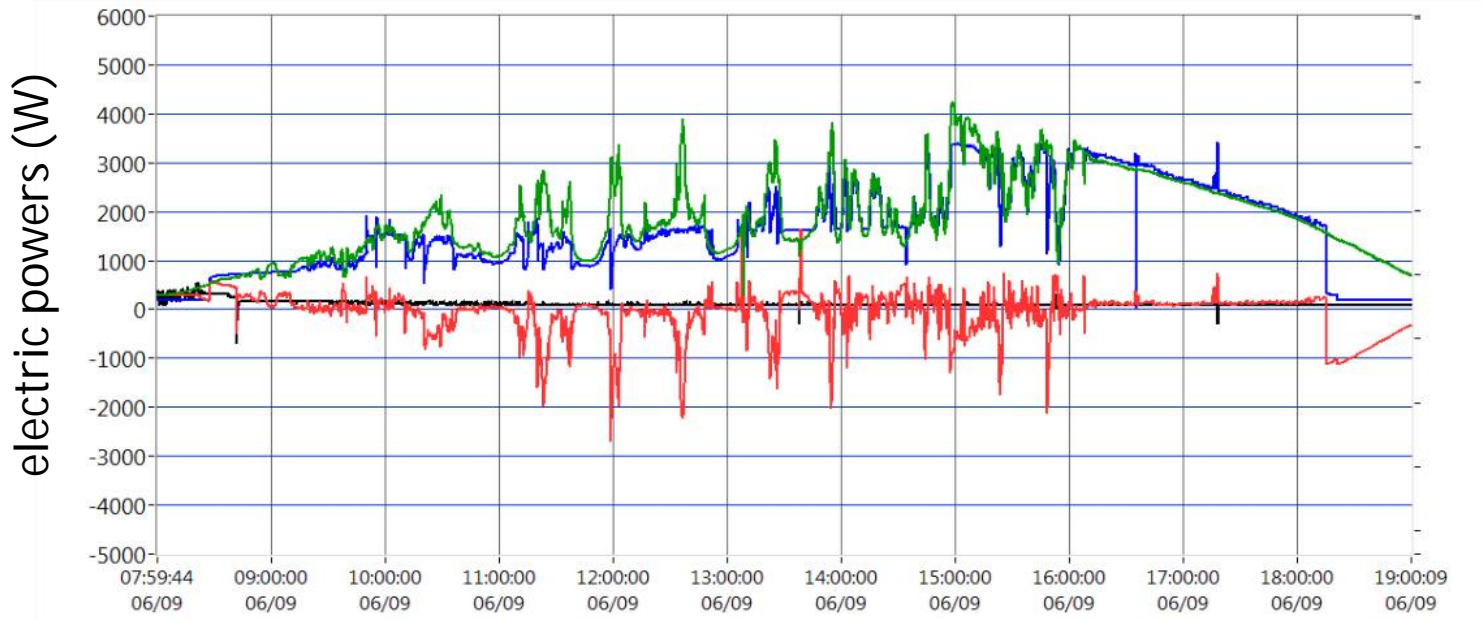

Building thermal load

Cooling power

Sunny day – “comfort” mode

14

PV power System consumption Battery power Grid power

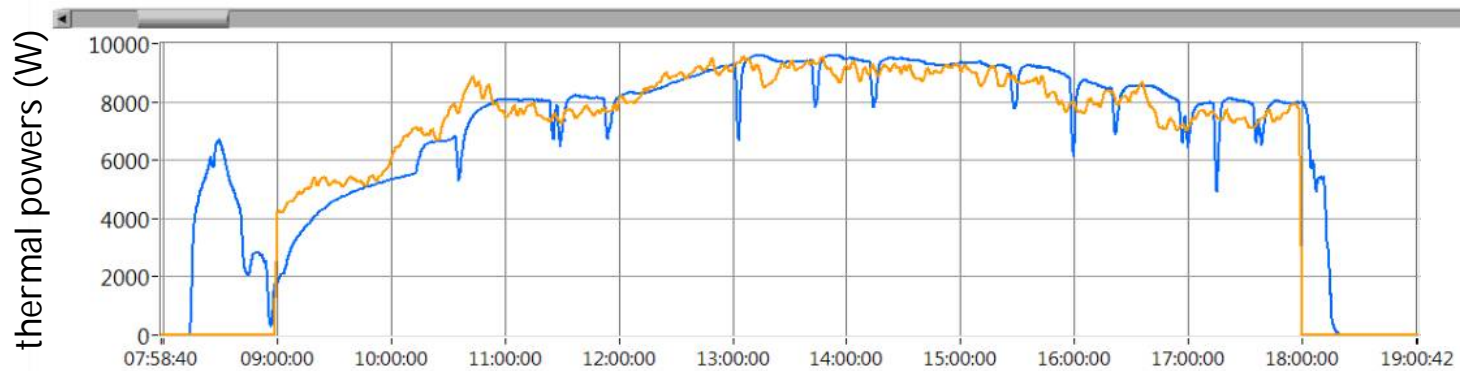
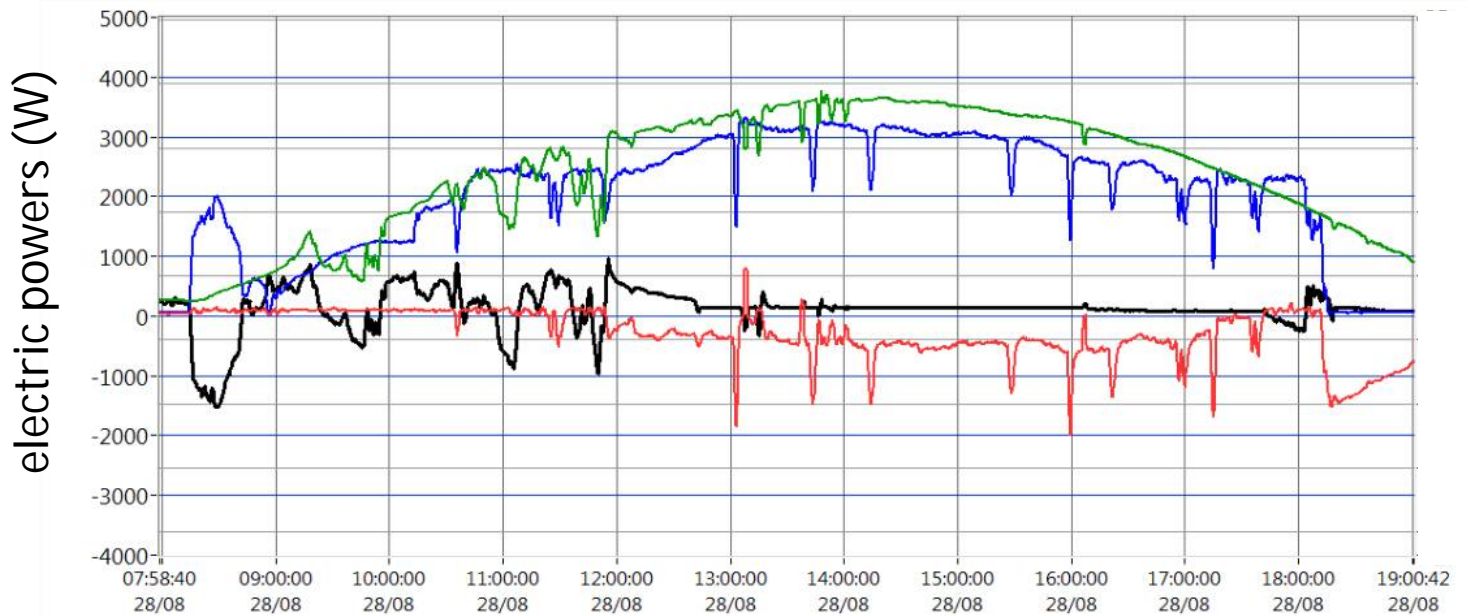

Building thermal load

Cooling power

Disrupted sunny/cloudy day – “comfort”

15

PV power System consumption Battery power Grid power

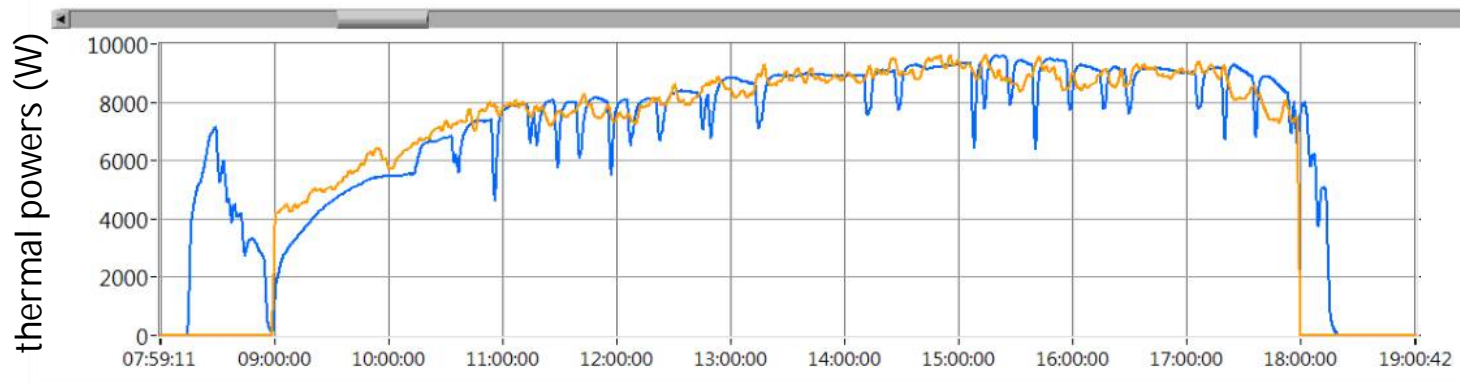
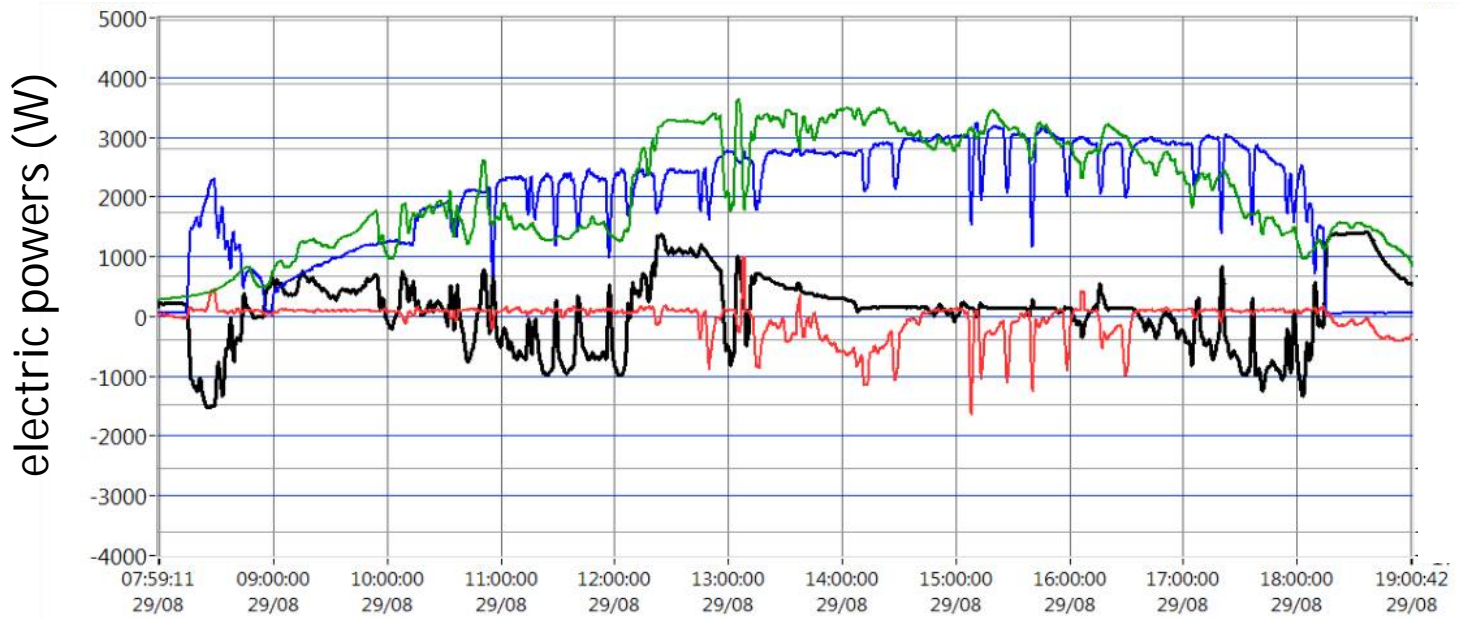

Building thermal load

Cooling power

Disrupted sunny/cloudy day – “comfort”

16

PV power System consumption Battery power Grid power

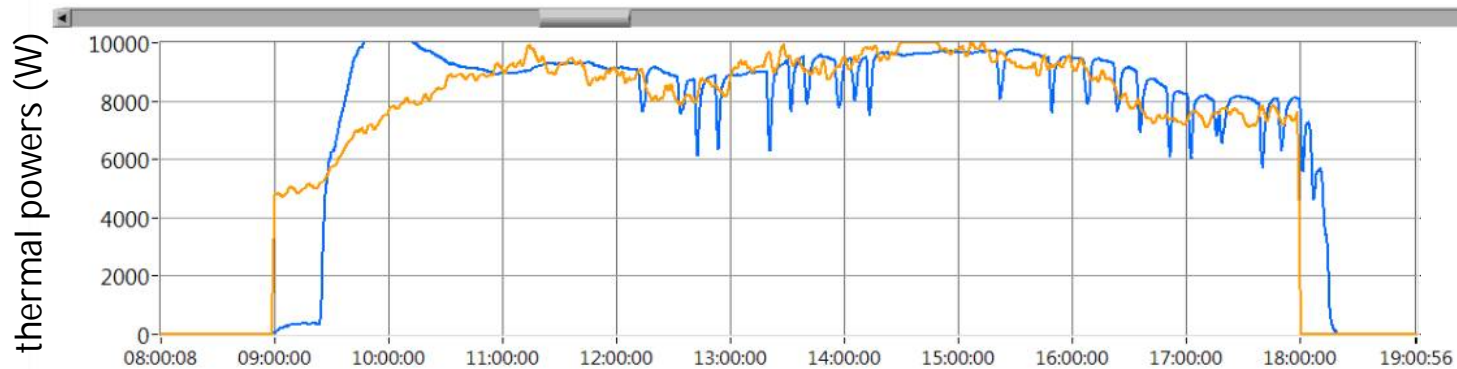
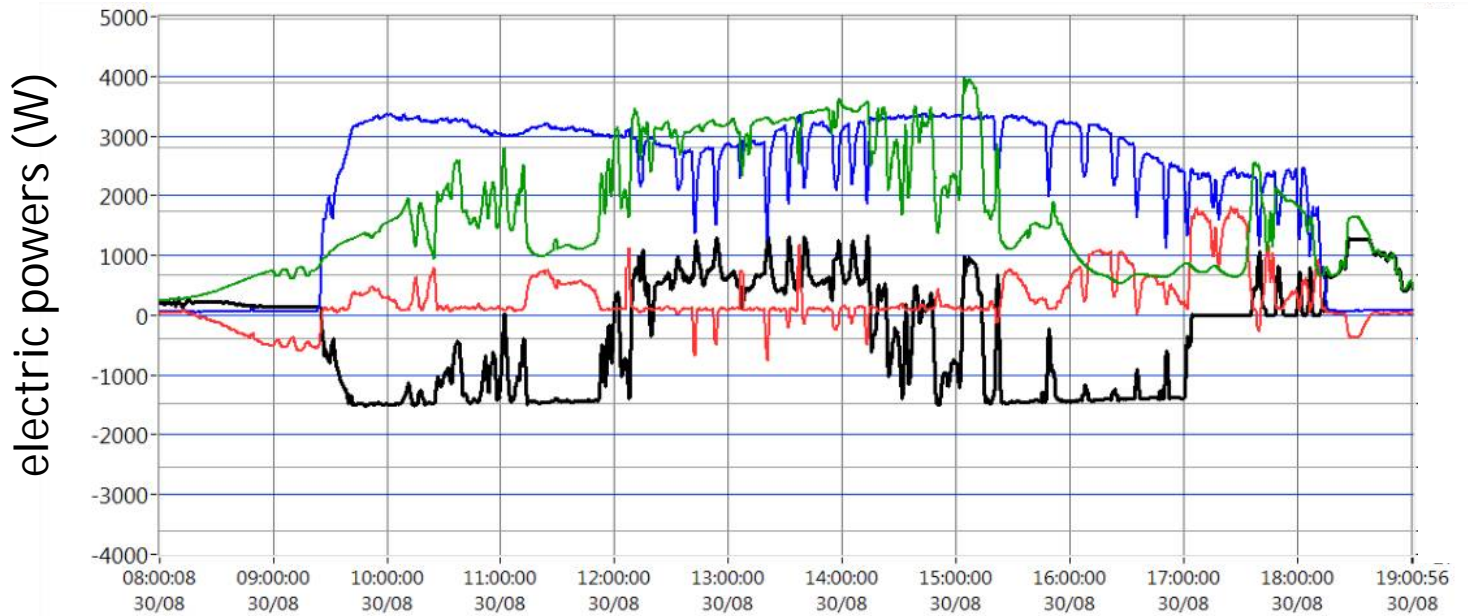

Building thermal load

Cooling power

PV-COOLING – SYNTHESIS OF DATA

17

data	"ECO" mode		"COMFORT" mode		
	sept 5th	sept 6th	Aug. 8th	Aug. 29th	Aug. th
overall electric PV-COOLING consumption (kWh)	14,52	17,87	22,62	22,22	25,24
PV-COOLING PV consumption (kWh)	14,11	16,64	21,29	19,26	15,95
PV energy production (kWh)	26,56	19,94	25,88	22,94	18,72
Battery consumption (kWh)	0,00	0,01	0,87	2,18	6,13
Grid consumption (kWh)	0,40	1,22	0,47	0,78	3,15
building thermal load (kWh)	38,64	51,74	71,15	72,04	75,99
Cooling production (kWh)	43,03	53,87	75,46	75,14	77,89
Compressor COP	3,40	3,36	2,91	2,96	2,82
PV-COOLING COP	2,96	3,02	2,72	2,76	2,64
PV-COOLING EER (Q_{th}/Q_{grid})	106,34	44,11	161,93	95,82	24,71

CONCLUSION

18

- possible to **combine photovoltaic (PV) power plant to drive vapor compression thermodynamic system** for the sake of producing cooling energy ;
- **Securing PV** plant with external power supply to drive thermodynamic system was successfully demonstrated ;
- Part of **efficiency results** in possibility to **real-time adapting cooling power to solar irradiation** ;
- EER obtained values shows that only **a limited amount of grid supply** is necessary
- Proper management permits one to consider **fully autonomous systems** disconnected from grid ;

PV-COOLING architecture (with optional thermal storage)

19

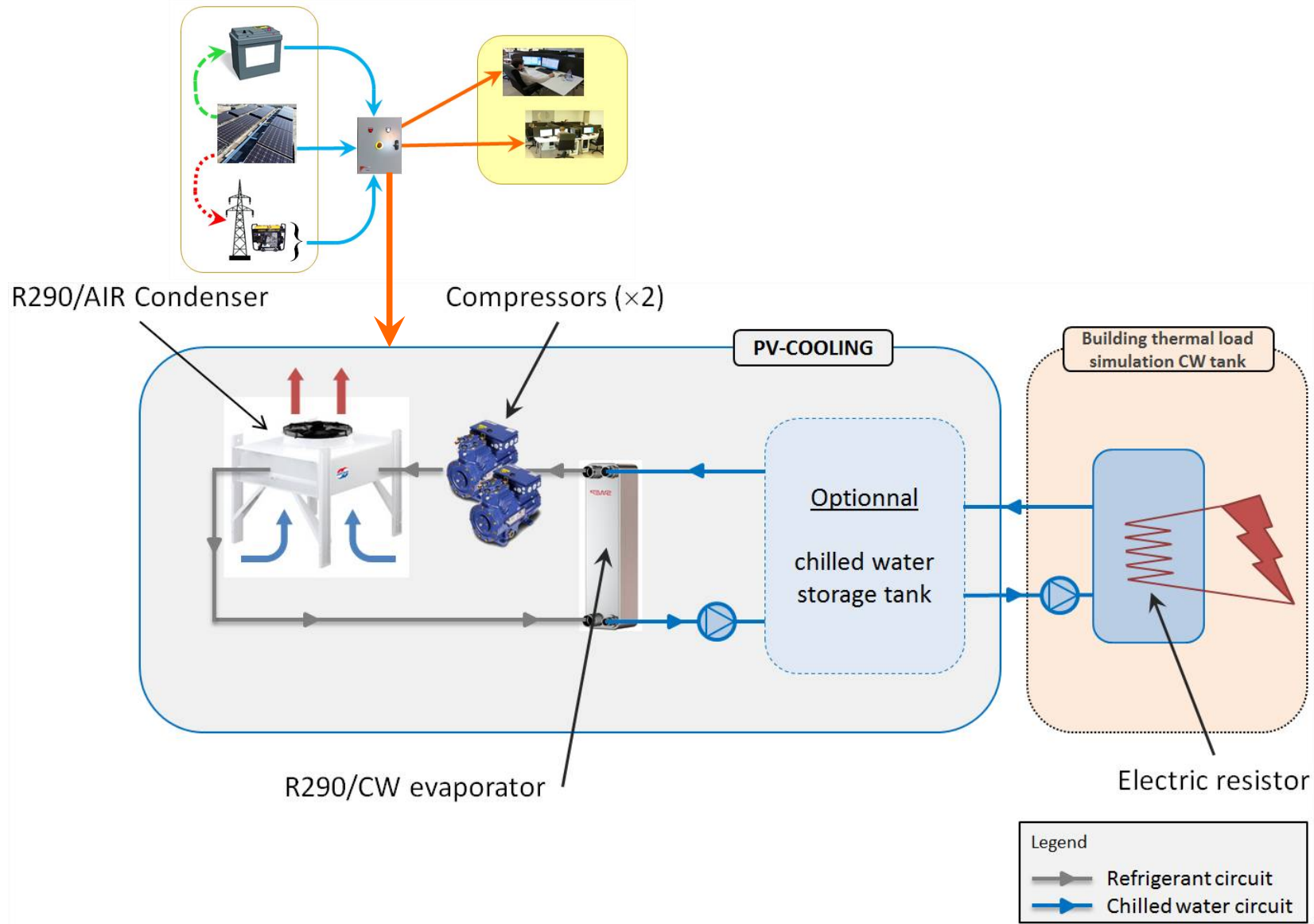

CONCLUSION

20

- **investigate** clever ways of **using PV excessive power**:
 - cold storage ,
 - electric storage
 - compare which is better to improve autonomy of PV-COOLING.

- Eventually, PV-COOLING concept open wide perspective for **insulated areas** and may constitute a **tool for land-use planning**, and especially in the **developing world**.

Thank you for attention

Video : <http://pvcooling.atisys.fr/video.php>

Real-time display : <http://pvcooling.atisys.fr/>

BUILDING THERMAL LOSS ESTIMATION (2)

22

$$P_{BuildLoad}(t) = \Delta T(t) \times \sum_i (Cp \cdot V_i \cdot \rho + D_i) + P_S \cdot \sum_i S_i \cdot K_i * \delta(t - \tau_i)$$

- ΔT : $\Delta T = (T_{ext} - T_{set})$ (outdoor temperature - indoor setpoint temperature)
- i : index associated to each building element “i”
- D_i : volume heat loss coefficient [W/m³.°C]
- V_i : the cooled volume; $\Sigma V_i = 325 \text{ m}^3$
- P_S : Power of solar irradiation [W/m²]
- S_i : time average wall surface of building element “i” exposed to solar irradiation ($\Sigma S_i = 40 \text{ m}^2$)”
- K_i : solar power absorption sensitivity of building walls [$0 \leq K \leq 1$](0.20)
- $\delta(t - \tau_i)$: delay function - thermal inertia of building to solar irradiation ($\tau = 1 \text{ hour}$)

www.iea-shc.org

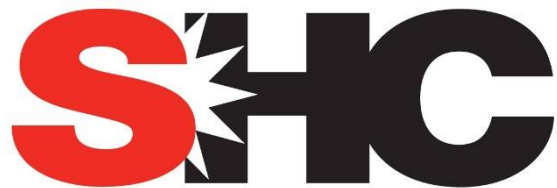

SOLAR HEATING & COOLING PROGRAMME
INTERNATIONAL ENERGY AGENCY