

IEA – SHC Task 44 / HPP Annex 38 Solar and Heat Pump Systems



Industry Newsletter
Third issue

Industry newsletter

Third issue, 2-2013

IEA – SHC Task 44 / HPP Annex 38

Solar and Heat Pump Systems

Elaborated by:

M. D'Antoni, R. Fedrizzi, W. Sparber

EURAC Research

With contributions by:

Michel Haller, SPF Solartechnik (Switzerland)

Martin Vukits, AEE Intec (Austria)

Erik Bertram, Institute for Solar Energy Research Hameln ISFH (Germany)

This newsletter presents three examples of commercially available Solar plus Heat Pumps systems monitored within IEA Task 44 / Annex 38. Here, domestic hot water and space heating demand of existing residential buildings are covered through the combination of a compression heat pump and solar thermal collectors. More detailed information are available in the referenced literature.



Task 44 / Annex 38

Solar and Heat Pump Systems

Background

Operating Agent:

Jean Christophe Hadorn
BASE Consultants SA
8 rue du Nant, 1207 Geneva
Switzerland
email: jchadorn@baseconsultants.com

Over the past few years, systems that combine solar thermal technology and heat pumps have been marketed to heat houses and produce domestic hot water. This new combination of technologies is a welcome advancement, but standards and norms are still required for its long term successful commercialization. Such combinations are complex and need more control strategies and electronics than separate configurations. Therefore the optimisation of the combination is more complex and the cost effectiveness of the combination is not obvious.

It has become very popular to heat a house with a heat pump solution due to the promotion undertaken by electrical utilities since a few years and the willingness of consumers not to depend upon fossil fuels. In some countries electricity is however produced by fossil fuels. More and more customers are thus attracted by a heat pump solution combined with a solar installation at least for domestic hot water preparation. Market for S+HP in countries like Switzerland, Austria, Germany are booming due to several favourable conditions like CO₂ reduction promotion programs, direct electrical heating substitution encouragement, obligation of a minimum of 30% renewable for domestic hot water production, high electricity peak cost and incentives.

Task 44 / Annex 38 – “Solar and Heat Pump Systems”

International collaboration through an IEA activity is an efficient way to share knowledge and new ideas on comparison and standardisation of such complex systems. Moreover the Task 44 of Solar heating and cooling called “Solar and heat pump systems” is also Annex 38 of the Heat Pump Programme, thus gathering experts from both technologies.

Like all IEA SHC Tasks, Task 44 / Annex 38 (T44A38) meets twice a year during two days where experts report the status and progress of their work and discuss new methods or tools for assessing and optimizing combinations of solar and heat pump. The task has been organized by the Operating Agent so as to separate important activities with clear boundaries and the minimum of overlapping.

Task Objectives

The objective of this Task is the assessment of performances and relevance of combined systems using solar thermal and heat pumps, to provide common definition of performances of such systems and to contribute to successful market penetration of these new systems.

Other objectives are needed to reach the main one where international collaboration is definitively needed to make it possible within a 4 years framework, mainly:

- surveying the possible generic combinations;
- defining performance figures of a combined solar and heat pump solution;
- defining assessment and test methods of such systems;
- analysing monitored data on such systems;
- developing component models or integrating existing ones into a system model;
- simulating various systems under common conditions;
- providing guidelines of good practice to the market and stakeholder;
- providing authorities with relevant information on the interest of such systems;
- staying close to the market and bringing independent information and knowledge to the actors on this market along the duration of the Task.

The scope of the Task considers solar thermal systems in combination with heat pumps, applied for the supply of domestic hot water and heating in family houses.

Duration of Task 44 / Annex 38

Task 44 / Annex 38 started in January 2010 and will end in December 2013. A number of deliverables will be available from time to time on the T44/A38 web site:

<http://www.iea-shc.org/task44/>.

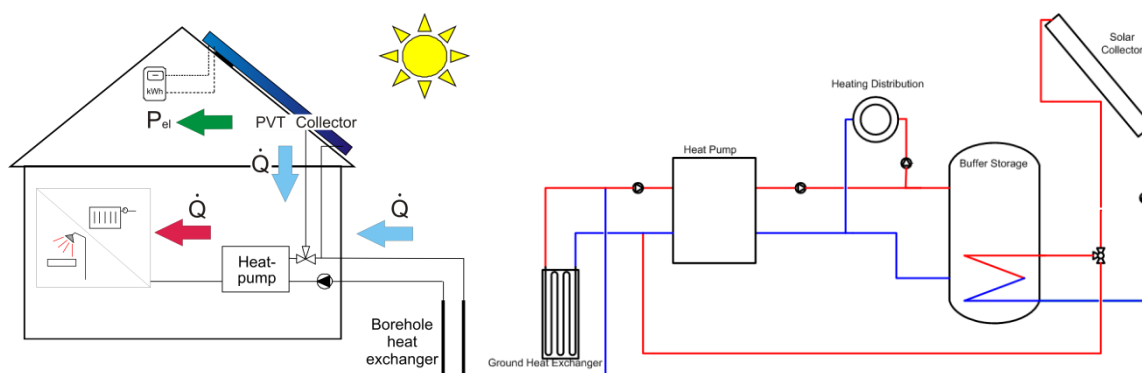

Figure 1: S+HP system: Example of a system including PV-T collectors and ground heat exchanger coupled with a water-to-water heat pump [source: ISFH and Fraunhofer ISE].

Subtasks

The work in this T44A38 is divided into four Subtasks:

- Subtask A: Overview of solutions (existing, new) and generic systems, led by Sebastian Herkel from Fraunhofer ISE of Stuttgart, Germany;
- Subtask B: Performance assessment, led by Ivan Malenkovic from the Austrian Institute of Technology (AIT);
- Subtask C: Modelling and simulation, led by Michel Haller from the SPF in Rapperswil, Switzerland;
- Subtask D: Dissemination and market support, led by Wolfram Sparber from the EURAC Research centre in Bolzano, Italy.

IEA SHC Task 44 / HPP Annex 38
Solar and Heat Pump Systems
www.iea.shc.org/task44

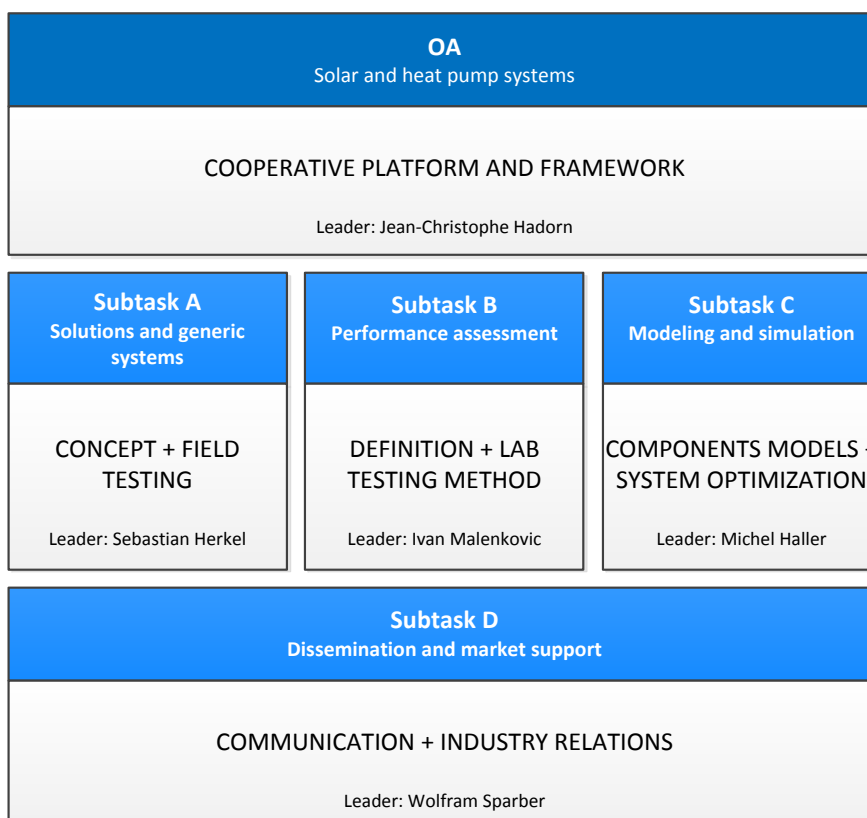
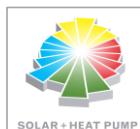

Introduction

The aim of the 3rd issue of T44A38 newsletter is to focus on monitoring results of Solar and Heat Pump (S+HP) systems. Since a raising number of standardized kits and solutions combining compression heat pumps and solar thermal collector for covering Domestic Hot Water and Space Heating demand are always more available on the market, it is of major interest to understand the actual performance in real operating conditions.

Within the multitude of different solutions combining solar energy with heat pump systems, three examples are here presented. Typical European residential buildings equipped with a S+HP system have been monitored for a year at least. Monitoring data are presented accordingly to IEA SHC Task 44 / HPP Annex 38 approach in calculating system performance figures. This work does not aim to report on the most efficient S+HP systems; it has to be seen as review of some existing systems.

- system boundary SHP:** it includes all components of a SHP system, excluding the heating, cooling and DHW distribution systems;

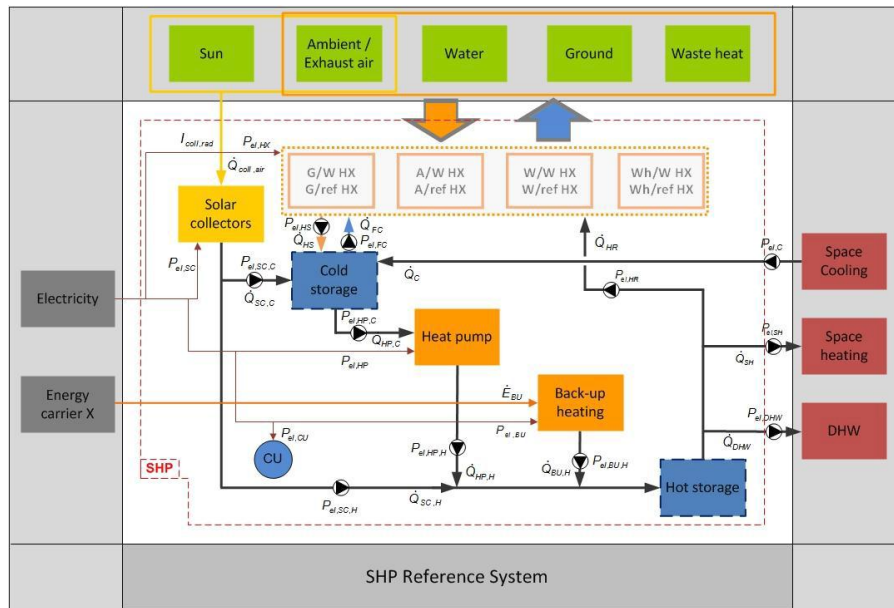

Figure 3: system boundary SHP [1].

- system boundary HP:** it is used for the performance evaluation of the compression heat pump;

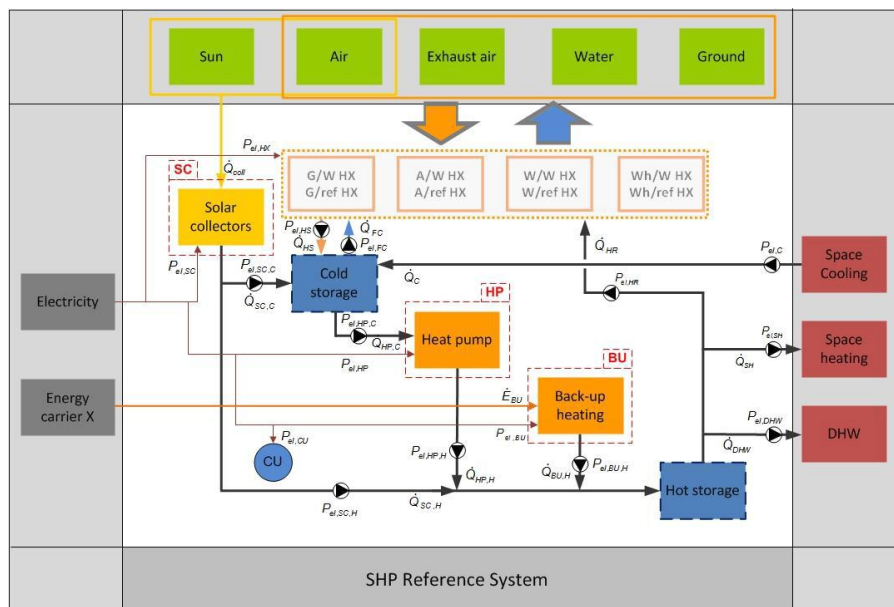

Figure 4: system boundary HP [1].

Solar plus Heat Pump system in Rapperswil-Jona (Switzerland)

System description

A combined air source heat pump and solar thermal heating system has been installed in a single family house in the city of Rapperswil-Jona (Switzerland) in 2009 and monitored from February 2010 to December 2011 [2]. The system provides domestic hot water (1400 kWh/y) for two people and space heating (18700 kWh/y) for 200 m² of heated floor area of a house built in 1992. A 15 m² covered solar-thermal collector field charges a tank-in-tank solar combi-storage of 1.8 m³ water volume, which can contribute for space heating and domestic hot water needs. The air-source heat pump has two stages of power (11 kW and 20 kW). It can cover space heating requirements or simultaneously it delivers heat to the combi-storage as secondary heat source to solar energy. The heat pump charges either the upper part or the middle part of the solar combi-storage directly (switching with two three-way valves) and the solar thermal collector field charges the solar combi-storage with internal heat exchangers placed in the top and in the bottom third of the combi-storage, of which the top heat exchanger can be circumvent.

All heat inputs and outputs of the store were monitored as well as the electricity consumption of the heat pump and the solar collector operation including all controllers and pumps with the exception of the space heat distribution pump. For the year 2011, the resulting seasonal performance factor of the system calculated based on all electricity use and the useful heat leaving the store was 4.4.

Technical data

Location	Rapperswil-Jona, Switzerland Coordinates: 47.2° N, 8.8° E Elevation: 409 m
Building	Typology: Single-family house (2 people) Living area: 200 m ² Space heating demand: 93.5 kWh/(m ² y) Domestic Hot Water demand: 7 kWh/(m ² y)
Heat Pump	Source: ambient air, reversible Heating capacity: 19.7 kW Performance: COP 3.8 (A2/W35 EN 14511)
Solar collectors	Orientation: 20° West Typology: flat-plate solar thermal collectors Thermal efficiency: $\eta_0=0.83$, $a_1=3.7$ W/(m ² K), $a_2=0.009$ W/(m ² K ²) Absorber area: 15 m ²
Storage	1800 l combi-storage (tank-in-tank type)

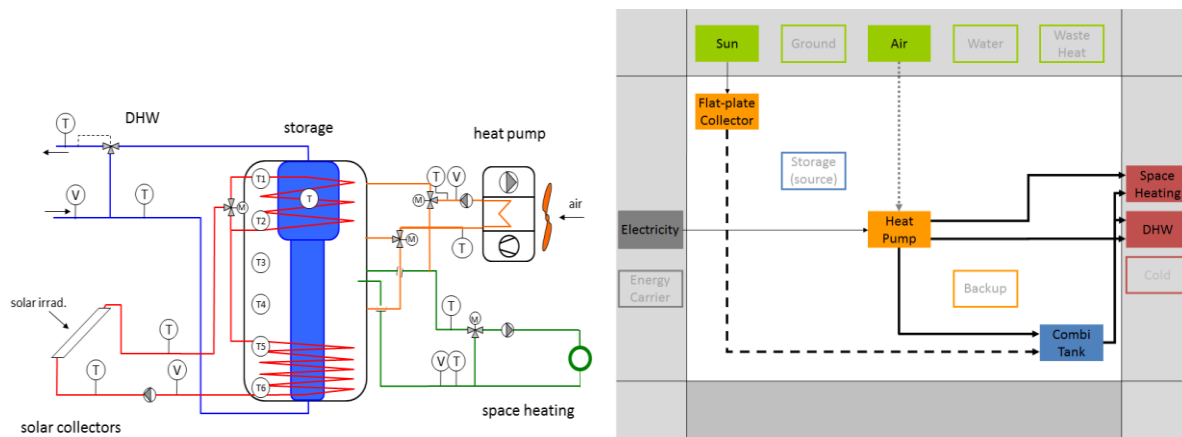

Figure 5: hydraulic scheme (left) and energy flow chart (right) [source: SPF Solartechnik].

Monitoring results

An energy monitoring has been undertaken from February 2010 to December 2011. Measured points included the flow and return temperatures and volume counts of the solar circuit, the heat pump circuit and the space heat circuit as well as cold water and hot water temperatures and tapped volumes. The monitoring used data sampling with 10 sec. intervals, storage was based on thresholds for changes of each single value and the evaluation (including power calculation and uncertainty calculation) was based on a sampling of the recorded data in 1 min. intervals.

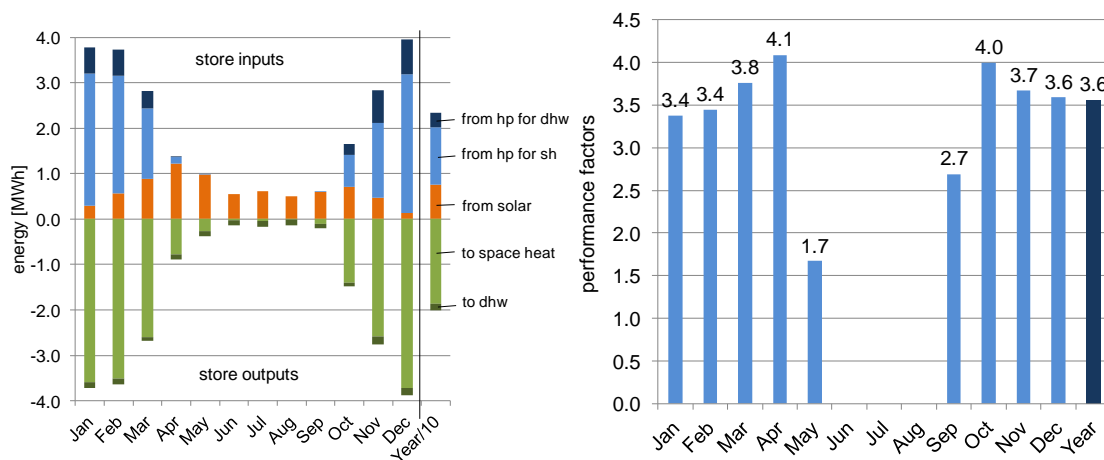

Figure 6: energy balance of the combi-store (left) and performance factor SPF_{HP} (right) [source: SPF Solartechnik].

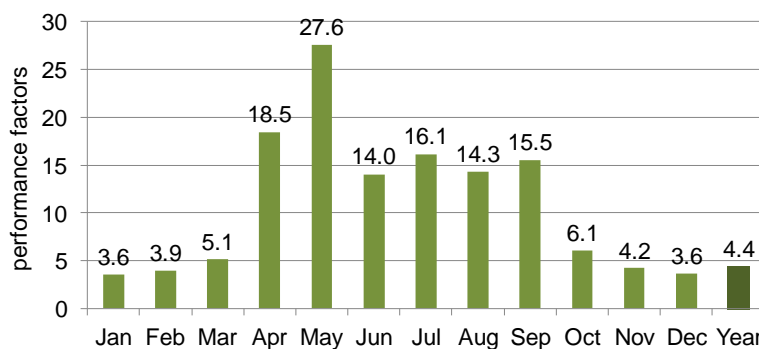

Figure 7: performance factor SPF_{SHP} of the system [source: SPF Solartechnik].

Solar plus Heat Pump system in Trofaiach (Austria)

System description

A combined air source heat pump and solar thermal heating system has been installed into a single family house with a small workshop (electrician) in Trofaiach (Austria) and monitored from October 2010 to February 2012 [3-4]. The system provides domestic hot water (2685.5 kWh/y) for 4 people and space heating (28094.3 kWh/y) for 300 m² heated floor area. The 9.5 kW air source heat pump and the 15 m² flat-plate collectors deliver heat to a combi-storage of 1000 l water volume from where the needs for space heat and domestic hot water are served. The energy from the solar collectors can also support the heat pumps evaporator. All heat inputs and outputs of the storage were monitored as well as the electricity consumption of the heat pump and the rest of the system. For the year 2011, the resulting seasonal performance factor of the system calculated based on all electricity use and the useful heat leaving the storage was 2.59.

Technical data

Location	Trofaiach, Austria Coordinates: 47.4° N, 15.0° E Elevation: 685 m
Building	Typology: Single-family house (4 people) Living area: 300 m ² Space heating demand: 93.65 kWh/(m ² y) Domestic Hot Water: 8.95 kWh/(m ² y)
Heat Pump	Source: ambient air and water (solar energy) Heating capacity: 9.5 kW Performance: COP 3.3 (A2/W35 EN 255)
Solar collectors	Orientation: 35° West Typology: flat-plate solar thermal collectors Thermal efficiency: $\eta_0=0.746$, $a_1=3.232$ W/(m ² K), $a_2=0.014$ W/(m ² K ²) Aperture area: 15 m ²
Storage	1000 l combi-storage with 2 immersed heat exchangers

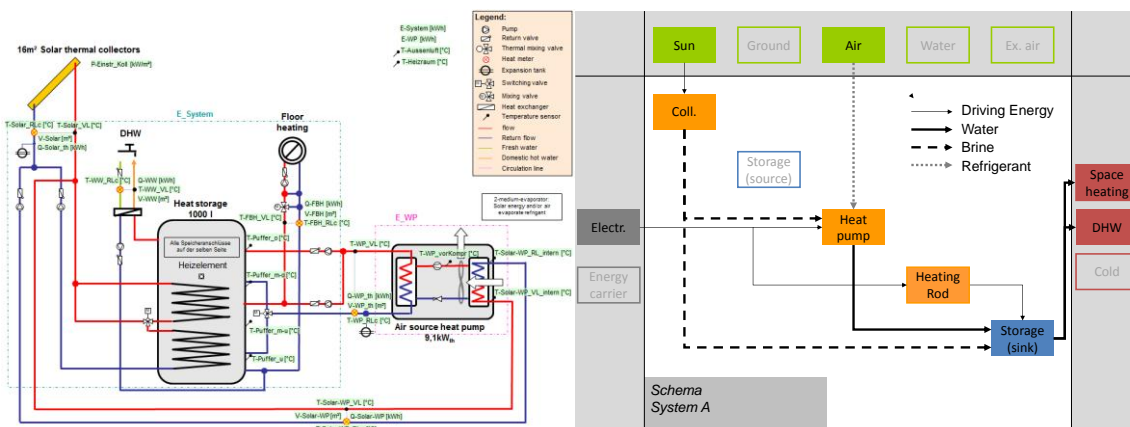

Figure 8: hydraulic scheme (left) and energy flow chart (right) [source: AEE Intec].

Monitoring results

The average ambient temperature during the monitored period was 8.1°C. Space heat demand and domestic hot water demand were 28094 kWh/y and 2685 kWh/y respectively, measured at the outlet of the storage. The solar collectors yielded 487 kWh/(m²y). The total electricity demand of the system including all controllers and pumps was 11868 kWh/y. The system's performance factor was 2.59 based on the useful heat leaving the storage. The performance factor for the heat pump was 2.65 and the storage efficiency reached 82%. The total system losses are about 6700 kWh/y, which equals about 17% of the total produced energy.

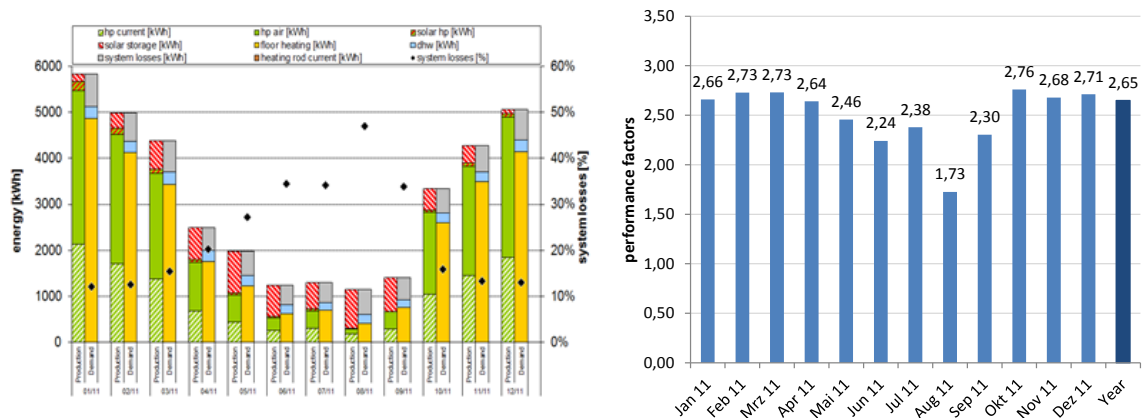

Figure 9: energy balance of the system (left) and performance factor SPF_{HP} (right) [source: AEE Intec].

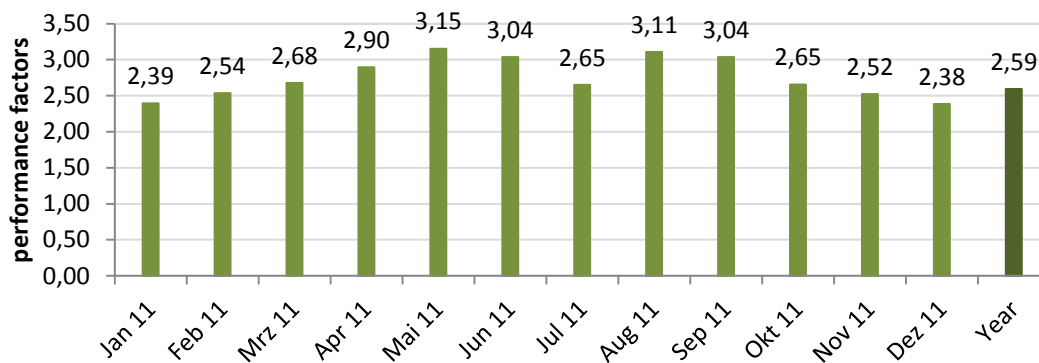

Figure 10: performance factor SPF_{SHP+} of the system [source: AEE Intec].

Solar plus Heat Pump system in Dreieich (Germany)

System description

A heat pump system with uncovered PVT and ground heat exchanger has been measured over a period of two years starting in March 2009 [5-8]. It consists of a 39 m² PVT-collector field, a 12 kW heat pump and a coaxial borehole heat exchanger with a total length of 225 m. The system provides space heat and domestic hot water for a large single family house.

As the thermal PVT-collector yield's impact on the heat pump performance cannot be measured directly, the measured data has been analyzed using a model of the combined solar and ground heat source in a TRNSYS simulation based on measured data.

Technical data

Location	Dreieich, Germany Coordinates: 50.0° N, 8.7° E Elevation: 140 m
Building	Typology: Single-family house (5 people) Living area: 380 m ² Space heating demand: 66.4 kWh/(m ² y) Domestic Hot Water: 6.2 kWh/(m ² y)
Heat Pump	Source: brine (PVT collectors + boreholes) Heating capacity: 11.6 kW Performance: COP 4.65 (B0/W35 EN 255)
Solar collectors	Orientation: 24° East Typology: uncovered PVT collectors Thermal efficiency: $\eta_0=0.56$, $b_1=8.8$ W/(m ² K), $b_2=0.55$ J/(m ³ K), $b_0=0.08$ s/m Electrical efficiency: 14% at STC conditions Aperture area: 39 m ²
Borehole	Typology: coaxial Length: 225 m Depth: 75 m Ground conductivity: 2.75 W/(mK)
Storage	150 l as DHW storage

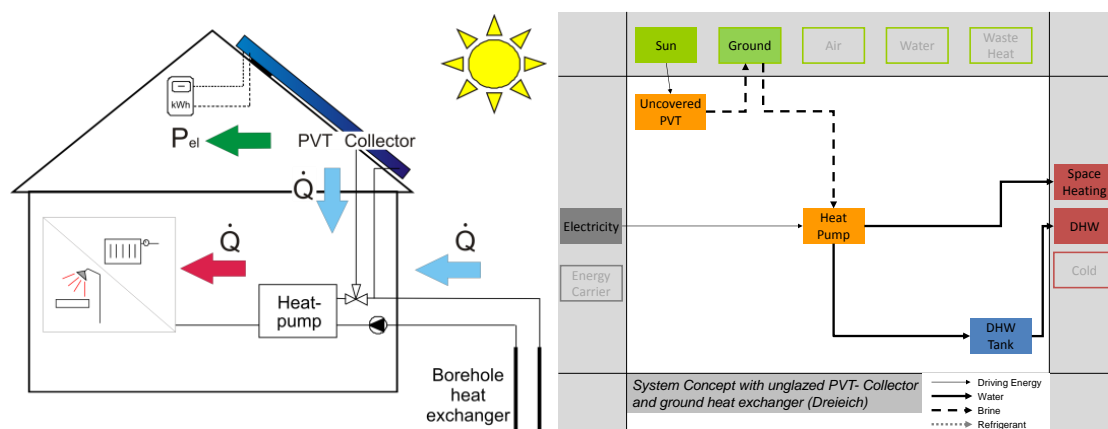

Figure 11: simplified hydraulic scheme (left) and energy flow chart (right) [source: ISFH].

Monitoring results

The planned overall heating demand is 28 MWh/y. However, the measured energy demand is much higher than calculated, presumably caused by high comfort requirements of the user with room temperatures up to 23°C. As a result the heating demand is 25% higher than dimensioned in the first year of operation and 45% higher than in the second year of operation. Nonetheless, the performance and temperature level of the ground heat exchanger is comparatively unchanged, because of the active ground regeneration by the solar thermal PVT- collector. The comparatively good stability of heat source temperatures highlights the robustness of the combined heat source unglazed solar collector and borehole heat exchanger.

Table 1: SPF and temperature levels for the measuring period system [source: ISFH].

Year of operation (April – April)	1 st Year 2009-2010	2 nd Year 2010-2011
SPF _{SHP+} [1]	3.9	4.0
SPF _{SHP} [1]	4.0	4.2
SPF _{HP} [1]	4.4	4.6
Energy averaged inlet temperature cold heat source side (+ ΔT)	5.9°C (+ 3.5 K)	4.7°C (+ 3.8 K)
Energy averaged outlet temperature hot heat sink side (+ ΔT)	34°C (+ 7.2 K)	35.9°C (+ 8.1 K)

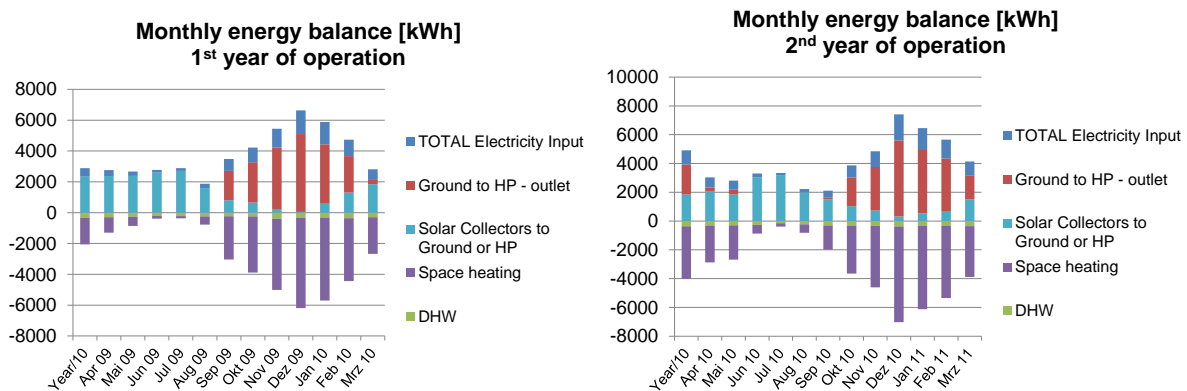

Figure 12: energy balance during the first (left) and second (right) year of operation of the system [source: ISFH].

For the PV yield measurements periods with snow and leaves were not respected. Days with missing or not suitable data were replaced by data from neighboring days, for instance tests of stagnation, blackouts that required MPP-tracker resetting or changing the heat pump in March 2010.

The PVT- collectors have been installed with and without rear side insulation. The measurement was conducted separately for both fields without significant differences for electrical and thermal yields. The Additional PV – yield due to cooling is measured to 4 % independent of rear side insulation.

Literature reference

1. Malenkovic, I., Eicher, S., Bony, J., "IEA SHC Task 44 / HPP Annex 38. Definition of main system boundaries and performance figures for reporting on SHP systems. A technical report of Subtask B. Deliverable B1.1", 2012.
2. Gemperle, S., "Analyse einer solarthermisch unterstützten Luft-Wasser-Wärmepumpenheizung", Bachelorarbeit an der Hochschule für Technik Rapperswil HSR, Institut für Solartechnik SPF, 21. Juni 2010, Rapperswil-Jona, Switzerland.
3. Thür A., Vukits M., Becke W., Heinz A., Lerch W. "Ein Jahr Feldmessung von sechs Solar-Kombianlagen mit Wärmepumpen", OTTI - 22. Symposium Thermische Solarenergie, Bad Staffelstein, 2012.
4. Lerch, W., Heinz, A., Thür, A., Vukits, M. "Optimierung von Solar-Wärmepumpen-Kombianlagen anhand von dynamischen Anlagensimulationen", OTTI - 22. Symposium Thermische Solarenergie, Bad Staffelstein, 2012.
5. Bertram, E., Stegmann, M., Scheuren, J., Rosinski, C., Kundmüller, K., "Unglazed Photovoltaic Thermal Collectors in Heat Pump Systems," presented at the EuroSun 2010 International Conference on Solar Heating, Cooling and Buildings, Graz, 2010.
6. Bertram, E., Glembin, J., Rockendorf G., "Unglazed PVT collectors as additional heat source in heat pump systems with borehole heat exchanger," Proceedings of SHC Conference 2012 in San Francisco, published in Energy Procedia, In Press.
7. Bertram, E., Stegmann, M., Rockendorf, G., "Solarthermie 2000plus: Solare Gebäudewärmeversorgung mit unverglasten photovoltaisch-thermischen Kollektoren, Erdsonden und Wärmepumpen für 100% Deckungsanteil", Teilprojekt B: Wissenschaftliche Begleitung. Emmerthal: , 2011. available at <http://edok01.tib.uni-hannover.de/edoks/e01fb12/684730588.pdf>.
8. Stegmann, M., Bertram, E., Rockendorf G., Janßen, S., "Model of an unglazed photovoltaic thermal collector based on standard test procedures," in Proceedings of ISES Solar World Congress, Kassel, Germany, 2011.

Task 44 / Annex 38 – Participants

<p>Aalto University School of Science and Technology Lämpömiehenkuja 2 02150 Espoo FINLAND www.aalto.fi</p> 	<p>AEE INTEC Institute for Sustainable Technologies Feldgasse 19 8200 Gleisdorf AUSTRIA www.aee-intec.at</p> 	<p>AIGUASOL ENGINYERIA C/ Roger de Llúria, 29 3r 2a 08009 Barcelona SPAIN www.aiguasol.com</p> 
<p>AIT Austrian Institute of Technology Giefinggasse 2 1210 Vienna AUSTRIA www.ait.ac.at</p> 	<p>ASIC Austria Solar Innovation Center Durisolstraße 7/Top 50 4600 Wels AUSTRIA www.asic.at</p> 	<p>Base Consultants SA 8 rue du Nant CP 6268 1211 Geneve SWITZERLAND www.baseconsultants.com</p> 
<p>CEA INES Institut National de l'Energie Solaire 50, Avenue du Lac Lemans 73377 Le Bourget du Lac France www.liten.fr www.ines-solaire.org</p> 	<p>CENERGIA Herlev Hovedgade 195 2730 Herlev DENMARK www.cenergia.dk</p> 	<p>Consolar Solare Energiesysteme GmbH Gewerbstrasse 7 79539 Lörrach GERMANY www.consolar.de</p> 
<p>DTI Danish Technological Institute Gregersensvej 3 2630 Taastrup DENMARK www.dti.dk</p> 	<p>DTU Technical University of Denmark Anker Engelundsvej 1 2800 Kgs. Lyngby DENMARK www.dtu.dk</p> 	<p>Ecole d'ingénieurs et d'architectes de Fribourg Bd de Pérolles 80 P.O. Box 32 1705 Fribourg SWITZERLAND www.eia-fr.ch</p> 

EDF R&D
Département Enerbat
Centre des Renardières
Avenue des Renardières Ecuelles
77818 Moret-sur-Loing
FRANCE
www.edf.fr



EHPA
European Heat Pump Association
Renewable Energy House
Rue d'Arlon 63-67
1040 Brussels
BELGIUM
www.ehpa.org



Ellehaug & Kildemoes
Vestergade 48 H,2s.tv.
8000 Århus C.
www.elle-kilde.dk



ENERGIE EST Ida
Zona industrial de Laúndos, Lote 48
4570-311 Laúndos / Póvoa de Varzim
PORTUGAL
www.energie.pt



Energie Solaire SA
CP 353 Z.I. Ile Falcon
3960 Sierre / Valais
SWITZERLAND
www.energie-solaire.com



EURAC research
European Accademy of Bolzano
Institute for Renewable Energy
Viale Druso/Drususallee 1
39100 Bolzano/Bozen
ITALY
www.eurac.edu



FHNW
Fachhochschule Nordwestschweiz
Institut Energie am Bau
Sankt-Jakobs Strasse 84
4132 Muttenz
SWITZERLAND
www.fhnw.ch/iebau



Fraunhofer-Institute for Solar Energy
Systems ISE
Heidenhofstraße 2
79110 Freiburg
GERMANY
www.ise.fraunhofer.de



HEIG-VD
School of Business and Engineering
Laboratory of Solar Energetics and
Building Physics (LESBAT),
Route de Cheseaux 1
1400 Yverdon-les-Bains
SWITZERLAND
www.heig-vd.ch



Haute Ecole d'Ingénierie et de Gestion
du Canton de Vaud

Hochschule für angewandte
Wissenschaften FH Ingolstadt
Esplanade 10
85049 Ingolstadt
GERMANY
www.haw-ingolstadt.de



ISFH
Institut für Solarenergieforschung GmbH
Hameln/Emmerthal
Am Ohrberg 1
31860 Emmerthal
GERMANY
www.isfh.de



ITW
Stuttgart University
Institut für Thermodynamik und
Wärmetechnik (ITW)
Pfaffenwaldring 6
70550 Stuttgart
www.itw.uni-stuttgart.de



KTH Royal Institute of Technology
Kungl Tekniska Högskolan, SE-100 44
STOCKHOLM
SWEDEN
www.kth.se



Lessius Mechelen campus De Nayer
Zandpoortvest 13
2800 Mechelen
BELGIUM
www.lessius.eu



LNEG
Laboratorio Nacional de Energia e
Geologia
Estrada do Paço do Lumiar, 22
1649-038 Lisboa
PORTUGAL
www.lneg.pt



Lund University
Box 117
221 00 Lund
SWEDEN
www.lunduniversity.lu.se



Natural Resources Canada
Innovation and Energy Technology
Sector
580 Booth Street, 13th floor
Ottawa, ON K1A 0E4
www.canmetenergy.gc.ca



NREL
National Renewable Energy Laboratory
1617 Cole Blvd.
Golden, CO 80401-3305
UNITED STATES
www.nrel.gov



Politecnico di Milano
Dipartimento di Energia
Via Lambruschini 4
20156 Milano
ITALY
www.polimi.it



RDmes
Institut Politècnic Campus Terrassa
(IPCT), TR21, Sala 16
Crta. Terrassa N-150 Km 14.5
08227 Terrassa
Barcelona
SPAIN
www.rdmes.com



Rheem Manufacturing Company
1100 Abernathy Road, Suite 1400
Atlanta, GA 30328
UNITED STATES
www.rheem.com



Sandia National Laboratories
PO Box 5800
Albuquerque, NM 87185
UNITED STATES
www.sandia.gov



Schüco International KG
Karolinenstraße 1-15
33609 Bielefeld
GERMANY
www.schueco.com



SERC
Solar Energy Research Center
School of Industrial Technology and
Management
Högskolan Dalarna
78188 Borlänge
www.du.de



Sonnenkraft GmbH
Clermont-Ferrand-Allee 34
93049 Regensburg
GERMANY
www.sonnenkraft.com



SP
Technical Research Institute of Sweden
Box 857
SE-501 15
Borås
SWEDEN



SPF
Institut für Solartechnik
Hochschule für Technik Rapperswil
HSR
Oberseestrasse 10
CH-8640 Rapperswil
SWITZERLAND
www.solarenergy.ch



TU Graz
Technische Universität Graz
Institut für Wärmetechnik (IWT)
Infeldgasse 25/B
8010 Graz
AUSTRIA
www.tugraz.at



University of Geneva
Bd du Pont-d'Arve 40
1211 GENÈVE
SWITZERLAND
www.unige.ch



University of Innsbruck
Innrain 52
6020 Innsbruck
AUSTRIA
www.uibk.ac.at



University of Applied Sciences of
Stuttgart
Schellingstr.24
70174 Stuttgart
www.hft-stuttgart.de

HFT Stuttgart

University of Applied Sciences

University of Palermo
Dept. DREAM
Viale delle Scienze 9
90128 Palermo
ITALY
www.dream.unipa.it



Universitat Politècnica de València
Camino de Vera
46022 Valencia
SPAIN
www.upv.es



UNIVERSITAT
POLITÈCNICA
DE VALÈNCIA

Vela Solaris
Brahmstraße 21
63768 Hösbach
GERMANY
www.polysun.ch

vela solaris

Wagner & Co Solartechnik GmbH
Zimmermannstr. 12
35091 Cölbe
GERMANY
www.wagner-solar.com



Wagner & Co
SOLARTECHNIK

Western Renewables Group
30012 Aventura, Suite A
CA 92688, Rancho Santa Margarita
UNITED STATES
www.westernrenewables.com

3S Swiss Solar Systems AG
Schachenweg 24
3250 Lyss
SWITZERLAND
www.3s-pv.ch



3S PHOTOVOLTAICS
SOLAR BUILDING TECHNOLOGIES